

AM-MIO RLM

Relay/Loop Module (RLM)

For Use With the AM-3, AE-1000, & AE-2000 Access Control Systems

Installation Instructions

Linear[®]

(760) 438-7000
USA & Canada (800) 421-1587 & (800) 392-0123
Toll Free FAX (800) 468-1340
www.linearcorp.com

PRODUCT DESCRIPTION

Up to three additional RLM modules can be added to fill the five-position module "rack". Each RLM module provides six Form "C" (normally open & normally closed) 5-amp relays for outputs and eight supervised loop terminals for inputs. With four RLM modules, the AM-MIO is capable of controlling 24 relay outputs and 32 loop inputs. Each module has a rotary switch to select its unique remote device address. The device address identifies each module to the system. Each module is interconnected to the controller by daisy-chained cables.

Pushbuttons on the RLM module are provided for manually triggering each relay for testing. Each relay has a red LED light to show when it's energized. A two-color red/green LED on the RLM module displays the status of the loop inputs. If all eight loops are "normal" (not shorted or open) the indicator is green. If any of the eight loops are "abnormal" (shorted or open) the indicator is red.

The power supply module (PSM) from the AM-MIO distributes power to the RLM module(s). An external 16 VAC transformer powers the supply and provides charging current for a 12-volt backup battery (up to 7 amp/hour capacity).

MODULE FEATURES

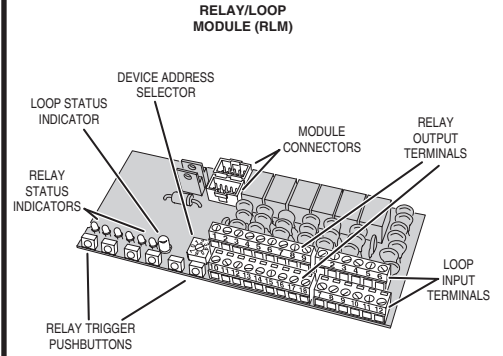

SETTING DEVICE ADDRESSES

SET THE MODULE TO A DIFFERENT DEVICE ADDRESS FROM THE EXISTING MODULES.

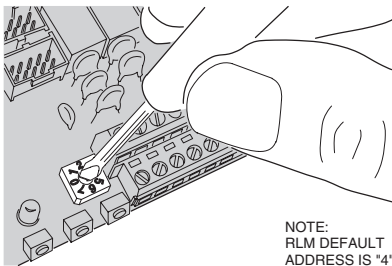

NOTE:
RLM DEFAULT ADDRESS IS "4"

THE ARROW IN THE SELECTOR SWITCH SLOT POINTS TO THE ADDRESS NUMBER (ADDRESS NUMBERS 1-6 ARE VALID)

CONNECTING MODULES

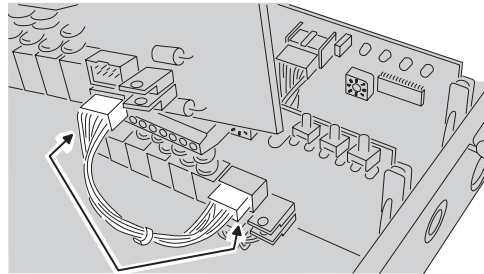

USE THE 10-WIRE CABLE TO CONNECT THE NEW RELAY/LOOP MODULE TO THE EXISTING MODULE PRIOR TO INSTALLING

ADDING MODULE

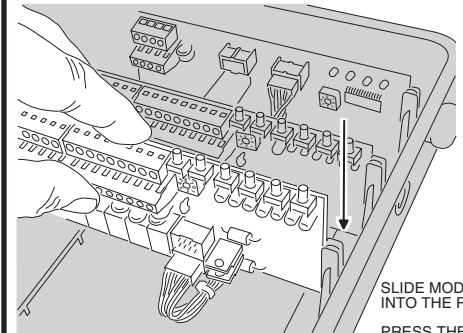

SLIDE MODULE INTO THE RACK
PRESS THE MODULE IN UNTIL IT SNAPS INTO PLACE

WIRING DIAGRAM

AM-MIO RLM WIRING DIAGRAM

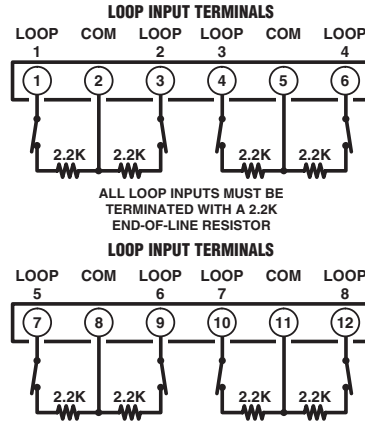
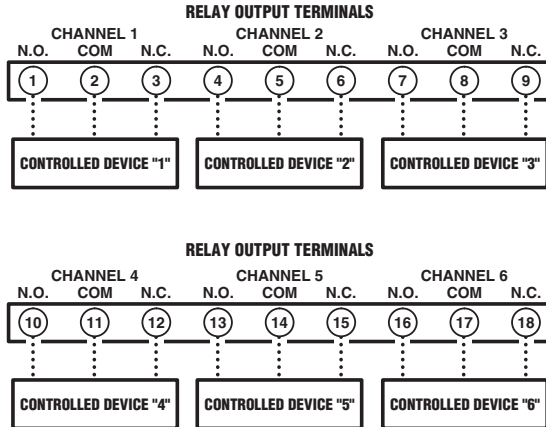

CONNECT RELAY OUTPUTS

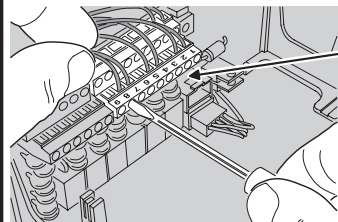

CONNECT RELAY OUTPUTS TO THE CONTROLLED DEVICES

RELAY RATING:
5 AMPS @
14 VDC
MAXIMUM

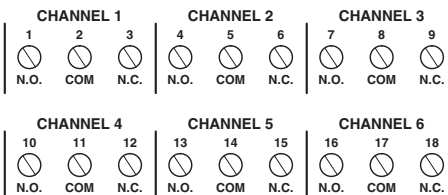

CONNECT LOOP OUTLETS

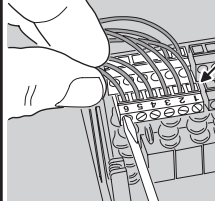

CONNECT ANY INPUTS TO THE LOOP INPUT TERMINALS

EACH LOOP INPUT CAN BE TRIGGERED WITH A NORMALLY OPEN OR NORMALLY CLOSED SWITCH

ALL LOOP INPUTS MUST BE TERMINATED WITH A 2.2K END-OF-LINE RESISTOR

EXAMPLE OF LOOPS 1-4 WITH NORMALLY CLOSED SWITCHES

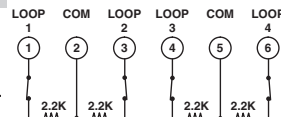

EXAMPLE OF LOOPS 5-8 WITH NORMALLY OPEN SWITCHES

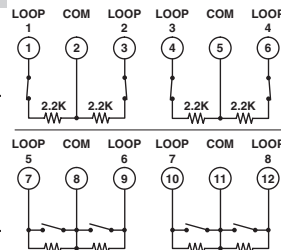

LINEAR LIMITED WARRANTY

This Linear product is warranted against defects in material and workmanship for twenty four (24) months. The Warranty Expiration Date is labeled on the product. This warranty extends only to wholesale customers who buy direct from Linear or through Linear's normal distribution channels. Linear does not warrant this product to consumers. Consumers should inquire from their selling dealer as to the nature of the dealer's warranty, if any. There are no obligations or liabilities on the part of Linear LLC for consequential damages arising out of or in connection with use or performance of this product or other indirect damages with respect to loss of property, revenue, or profit, or cost of removal, installation, or reinstallation. All implied warranties, including implied warranties for merchantability and implied warranties for fitness, are void only until Warranty Expiration Date as labeled on the product. This Linear LLC Warranty is in lieu of all other warranties express or implied.

All products returned for warranty service require a Return Product Authorization Number (RPA#). Contact Linear Technical Service at 1-800-421-1587 for an RPA# and other important details.

IMPORTANT

Linear radio controls provide a reliable communications link and fill an important need in portable wireless signalling. However, there are some limitations which must be observed.

- For U.S. installations only: The radios are required to comply with FCC Rules and Regulations as Part 15 devices. As such, they have limited transmitter power and therefore limited range.
- A receiver cannot respond to more than one transmitted signal at a time and may be blocked by radio signals that occur on or near their operating frequencies, regardless of code settings.
- Changes or modifications to the device may void FCC compliance.
- In frequently used radio links should be tested regularly to protect against undetected interference or fault.
- A general knowledge of radio and its vagaries should be gained prior to acting as a wholesale distributor or dealer, and these facts should be communicated to the ultimate users.